



森特奈

SENTINEL ELECTRONICS



Proximity Sensors

创新驱动智造，用心服务客户
SENSING YOUR MIND!

Proximity Seneors

Inductive Sensors

As a detection device, sensors can sense the measured information, and can transform the sensed information into electrical signals or other required forms, so as to meet the requirements of information transmission, processing, storage, display, records and controls, etc.



In today's society, sensors have already penetrated into an extremely broad field, and almost every modern project is inseparable from a variety of sensor. SENTINEL provides customers with a variety of sensor products such as flow, pressure, temperature, proximity, speed, etc., to achieve customer-customized measurement solutions.

Inductive Sensors

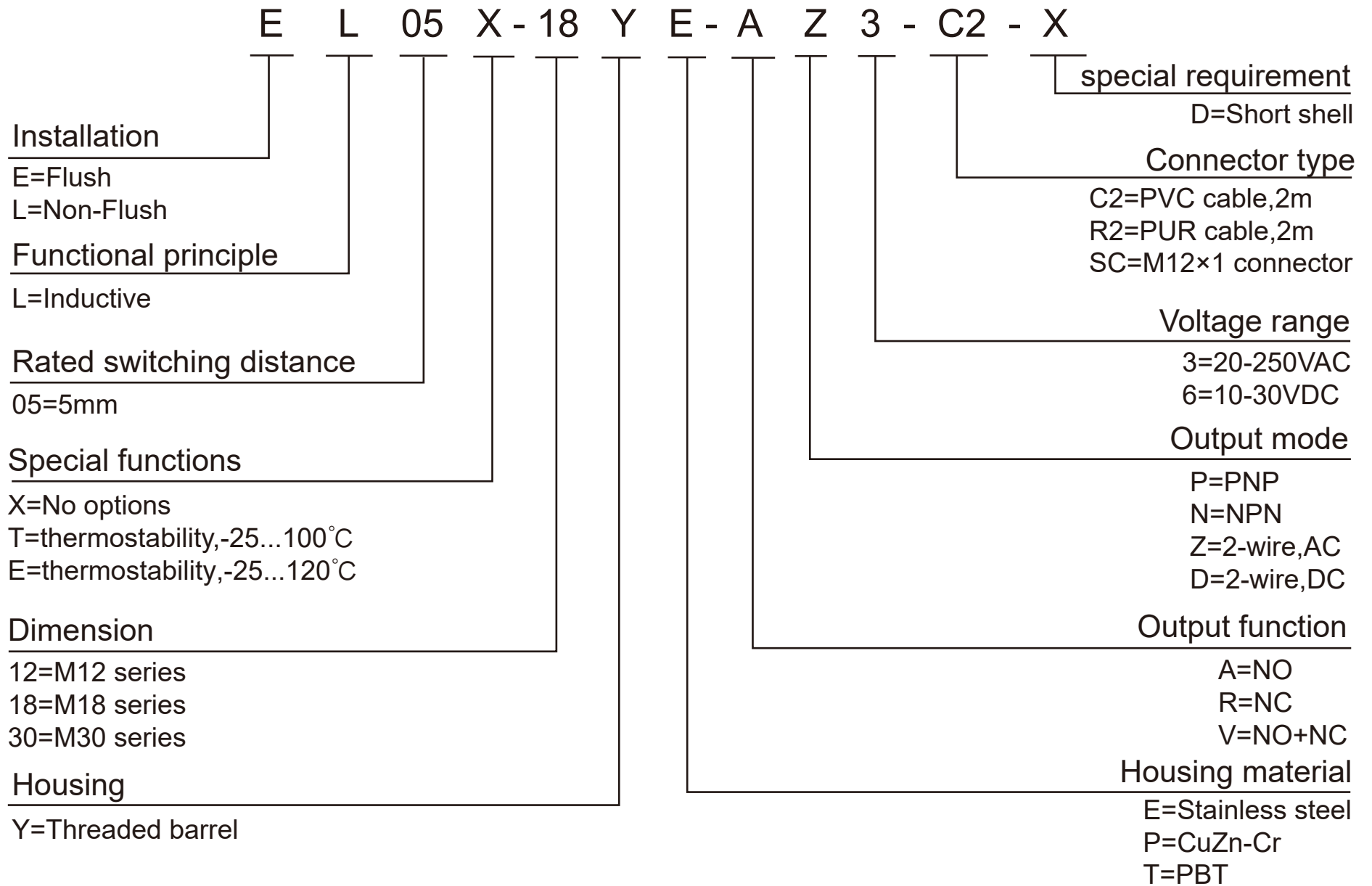

Dimensions

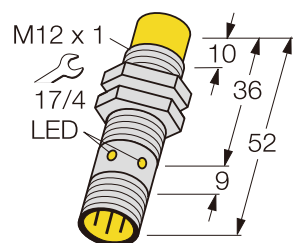

DC

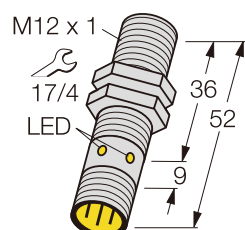

DC

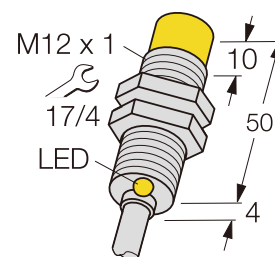

DC

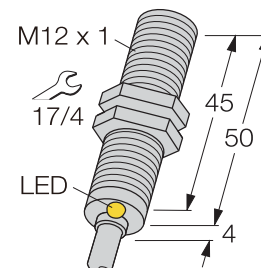

DC

Type

TL04X-12YP-AP6-SC
TL04X-12YP-RP6-SC
TL04X-12YP-AN6-SC
TL04X-12YP-RN6-SC

EL04X-12YP-AP6-SC
EL04X-12YP-RP6-SC
EL04X-12YP-AN6-SC
EL04X-12YP-RN6-SC

TL04X-12YP-AP6-C2
TL04X-12YP-RP6-C2
TL04X-12YP-AN6-C2
TL04X-12YP-RN6-C2

EL04X-12YP-AP6-C2
EL04X-12YP-RP6-C2
EL04X-12YP-AN6-C2
EL04X-12YP-RN6-C2

Order number

12404034
12404064
12404014
12404024

10404034
10404064
10404014
10404024

12401011
12401061
12401011
12401021

10404031
10404061
10404011
10404021

Rated switching distance

4mm

4mm

4mm

4mm

Mounting conditions

Non-flush

Flush

Non-flush

Flush

Electrical connection

Connector, M12×1

Cable(2m)

Output

PNP NO
PNP NC
NPN NO
NPN NC

Housing size

M12×1 threaded barrel

Operating voltage

10...30VDC

DC rated operational current

≤100mA

Repeat accuracy

≤5 %Sr

Protection class

IP67

Reverse polarity protection

YES

Short-circuit protection

YES

Housing material

CuZn-Cr

Ambient temperature

-25...70°C

Switching frequency

1KHZ

Switching state

LED, Yellow

Dimensions

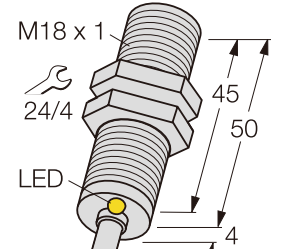
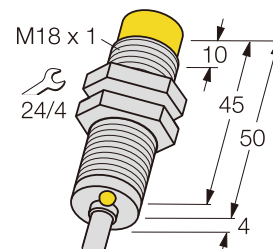
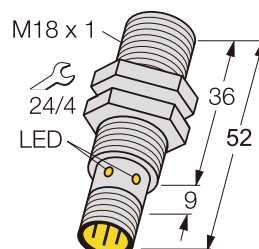
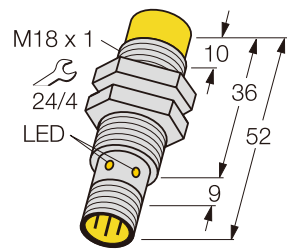

DC



DC



DC



DC

TL08X-18YP-AP6-SC
TL08X-18YP-RP6-SC
TL08X-18YP-AN6-SC
TL08X-18YP-RN6-SC

EL05X-18YP-AP6-SC
EL05X-18YP-RP6-SC
EL05X-18YP-AN6-SC
EL05X-18YP-RN6-SC

TL08X-18YP-AP6-C2
TL08X-18YP-RP6-C2
TL08X-18YP-AN6-C2
TL08X-18YP-RN6-C2

EL05X-18YP-AP6-C2
EL05X-18YP-RP6-C2
EL05X-18YP-AN6-C2
EL05X-18YP-RN6-C2

Type

| | | | | |
|------------------------------|--|--|--|--|
| Order number | 12802034 12802064 12802014 12802024 | 10802034 10802064 10802014 10802024 | 12802031 12802061 12802011 12802021 | 10802031 10802031 10802011 10802021 |
| Rated switching distance | 8mm | 5mm | 8mm | 5mm |
| Mounting conditions | Non-flush | Flush | Non-flush | Flush |
| Electrical connection | Connector, M12×1 | | Cable(2m) | |
| Output | PNP NO PNP NC NPN NO NPN NC | | | |
| Housing size | M18×1 threaded barrel | | | |
| Operating voltage | 10...30VDC | | | |
| DC rated operational current | ≤100mA | | | |
| Repeat accuracy | ≤5 %Sr | | | |
| Protection class | IP67 | | | |
| Reverse polarity protection | YES | | | |
| Short-circuit protection | YES | | | |
| Housing material | CuZn-Cr | | | |
| Ambient temperature | -25...70°C | | | |
| Switching frequency | 1KHZ | | | |
| Switching state | LED, Yellow | | | |

Dimensions

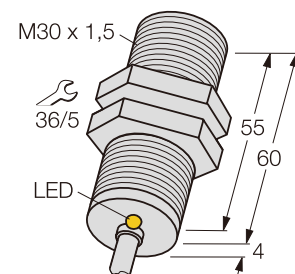
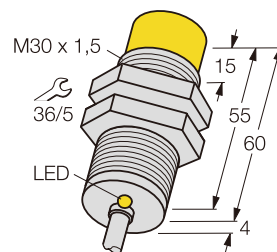
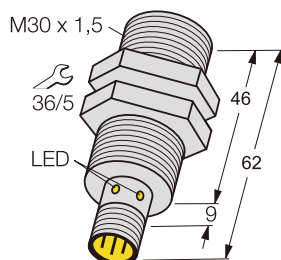
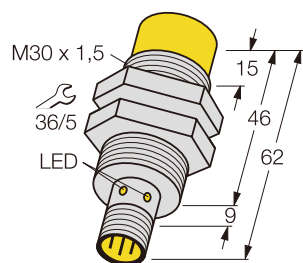

DC



DC



DC



DC

Type

TL20X-30YP-AP6-SC
TL20X-30YP-RP6-SC
TL20X-30YP-AN6-SC
TL20X-30YP-RN6-SC

EL10X-30YP-AP6-SC
EL10X-30YP-RP6-SC
EL10X-30YP-AN6-SC
EL10X-30YP-RN6-SC

TL15X-30YP-AP6-C2
TL15X-30YP-RP6-C2
TL15X-30YP-AN6-C2
TL15X-30YP-RN6-C2

EL10X-30YP-AP6-C2
EL10X-30YP-RP6-C2
EL10X-30YP-AN6-C2
EL10X-30YP-RN6-C2

Order number

13505034
13505064
13505014
13505024

11705034
11705064
11305014
11305024

13305031
13305061
13305011
13305021

11305031
11305061
11305011
11305021

Rated switching distance

20mm

10mm

15mm

10mm

Mounting conditions

Non-flush

Flush

Non-flush

Flush

Electrical connection

Connector, M12×1

Cable(2m)

Output

PNP NO
PNP NC
NPN NO
NPN NC

Housing size

M30×1 threaded barrel

Operating voltage

10...30VDC

DC rated operational current

≤100mA

Repeat accuracy

≤5 %Sr

Protection class

IP67

Reverse polarity protection

YES

Short-circuit protection

YES

Housing material

CuZn-Cr

Ambient temperature

-25...70°C

Switching frequency

1KHZ

Switching state

LED, Yellow

Dimensions

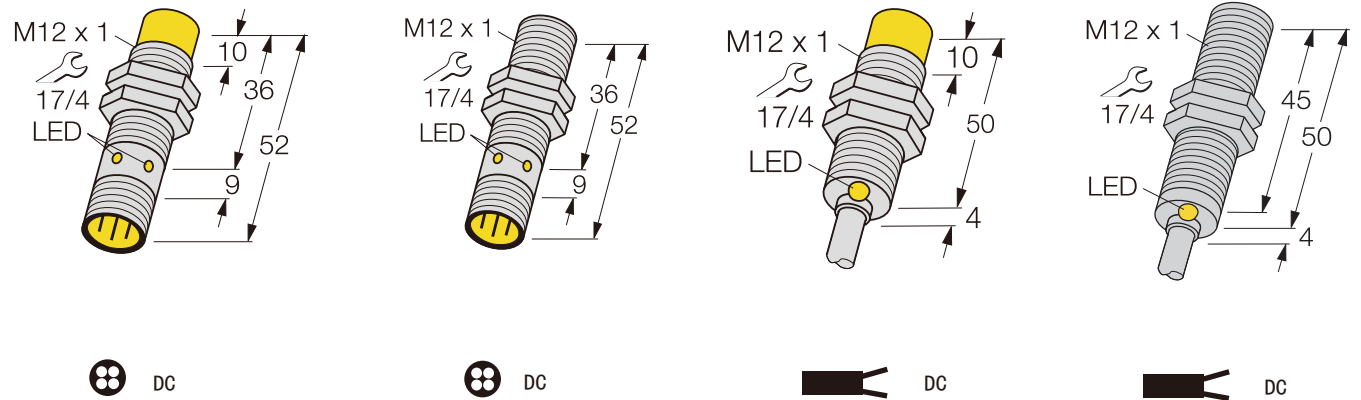

| Type | TL04X-12YP-AD6-SC | EL02X-12YP-AD6-SC | TL04X-12YP-AD6-C2 | EL02X-12YP-AD6-C2 |
|------------------------------|-----------------------|-------------------|-------------------|-------------------|
| Order number | 12404084 | 10404084 | 12404081 | 10404081 |
| Rated switching distance | 4mm | 2mm | 4mm | 2mm |
| Mounting conditions | Non-flush | Flush | Non-flush | Flush |
| Electrical connection | Connector, M12×1 | | Cable(2m) | |
| Output | NO contact, 2-wire | | | |
| Housing size | M12×1 threaded barrel | | | |
| Operating voltage | 10...30VDC | | | |
| DC rated operational current | ≤100mA | | | |
| Repeat accuracy | ≤5 %Sr | | | |
| Protection class | IP67 | | | |
| Reverse polarity protection | YES | | | |
| Short-circuit protection | YES | | | |
| Housing material | CuZn-Cr | | | |
| Ambient temperature | -25...70°C | | | |
| Switching frequency | 500HZ | | | |
| Switching state | LED, Yellow | | | |

Dimensions

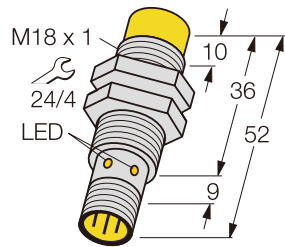

DC

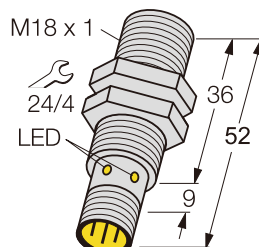

DC

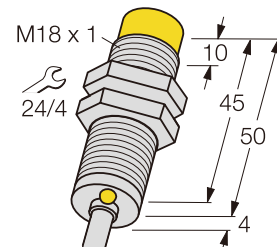

DC

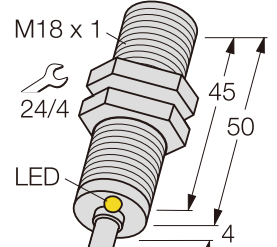

DC

Type

TL08X-18YP-AD6-SC EL05X-18YP-AD6-SC TL08X-18YP-AD6-C2 EL05X-18YP-AD6-C2

| | | | | |
|------------------------------|-----------------------|----------|-----------|----------|
| Order number | 12802084 | 10802084 | 12802081 | 10802081 |
| Rated switching distance | 8mm | 5mm | 8mm | 5mm |
| Mounting conditions | Non-flush | Flush | Non-flush | Flush |
| Electrical connection | Connector, M12×1 | | Cable(2m) | |
| Output | NO contact, 2-wire | | | |
| Housing size | M18×1 threaded barrel | | | |
| Operating voltage | 10...30VDC | | | |
| DC rated operational current | ≤100mA | | | |
| Repeat accuracy | ≤5 %Sr | | | |
| Protection class | IP67 | | | |
| Reverse polarity protection | YES | | | |
| Short-circuit protection | YES | | | |
| Housing material | CuZn-Cr | | | |
| Ambient temperature | -25...70°C | | | |
| Switching frequency | 500HZ | | | |
| Switching state | LED, Yellow | | | |

Dimensions

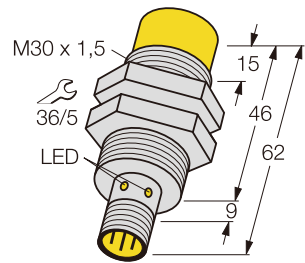

DC

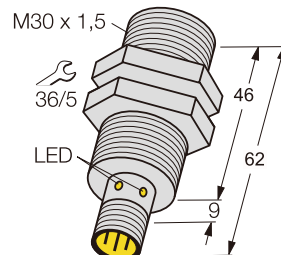

DC

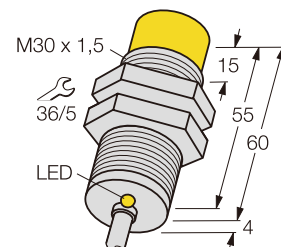

DC

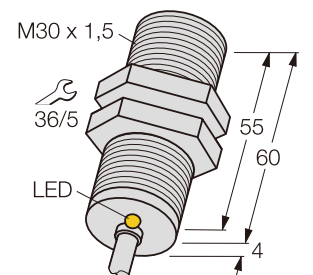

DC

Type

TL15X-30YP-AD6-SC

EL10X-30YP-AD6-SC

TL15X-30YP-AD6-C2

EL10X-30YP-AD6-C2

| | | | | |
|------------------------------|-----------------------|----------|-----------|----------|
| Order number | 13305084 | 11305084 | 13305081 | 11305081 |
| Rated switching distance | 15mm | 10mm | 15mm | 10mm |
| Mounting conditions | Non-flush | Flush | Non-flush | Flush |
| Electrical connection | Connector, M12×1 | | Cable(2m) | |
| Output | NO contact, 2-wire | | | |
| Housing size | M30×1 threaded barrel | | | |
| Operating voltage | 10...30VDC | | | |
| DC rated operational current | ≤100mA | | | |
| Repeat accuracy | ≤5 %Sr | | | |
| Protection class | IP67 | | | |
| Reverse polarity protection | YES | | | |
| Short-circuit protection | YES | | | |
| Housing material | CuZn-Cr | | | |
| Ambient temperature | -25...70°C | | | |
| Switching frequency | 500HZ | | | |
| Switching state | LED, Yellow | | | |

Dimensions

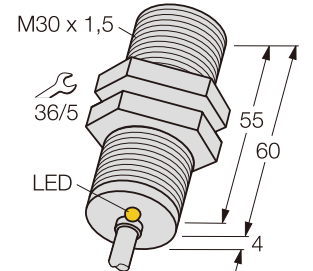
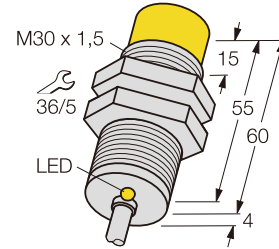
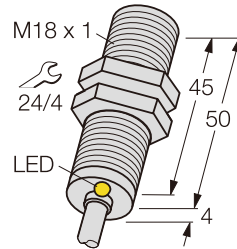
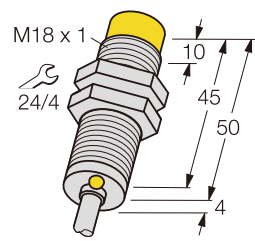

| Type | TL08X-18YP-AZ3-C2 | EL05X-18YP-AZ3-C2 | TL15X-30YP-AZ3-C2 | EL10X-30YP-AZ3-C2 |
|------------------------------|-----------------------|-------------------|-----------------------|-------------------|
| Order number | 12802091 | 10802091 | 13305091 | 11305091 |
| Rated switching distance | 8mm | 5mm | 15mm | 10mm |
| Mounting conditions | Non-flush | Flush | Non-flush | Flush |
| Housing size | M18×1 threaded barrel | | M30×1 threaded barrel | |
| Electrical connection | Cable(2m) | | | |
| Output | NO contact, 2-wire | | | |
| Operating voltage | 20...250VAC | | | |
| DC rated operational current | ≤100mA | | | |
| Repeat accuracy | ≤5 %Sr | | | |
| Protection class | IP67 | | | |
| Reverse polarity protection | YES | | | |
| Short-circuit protection | YES | | | |
| Housing material | CuZn-Cr | | | |
| Ambient temperature | -25...70°C | | | |
| Switching frequency | 500HZ | | | |
| Switching state | LED, Yellow | | | |

Inductive Sensors

Rotation speed monitor

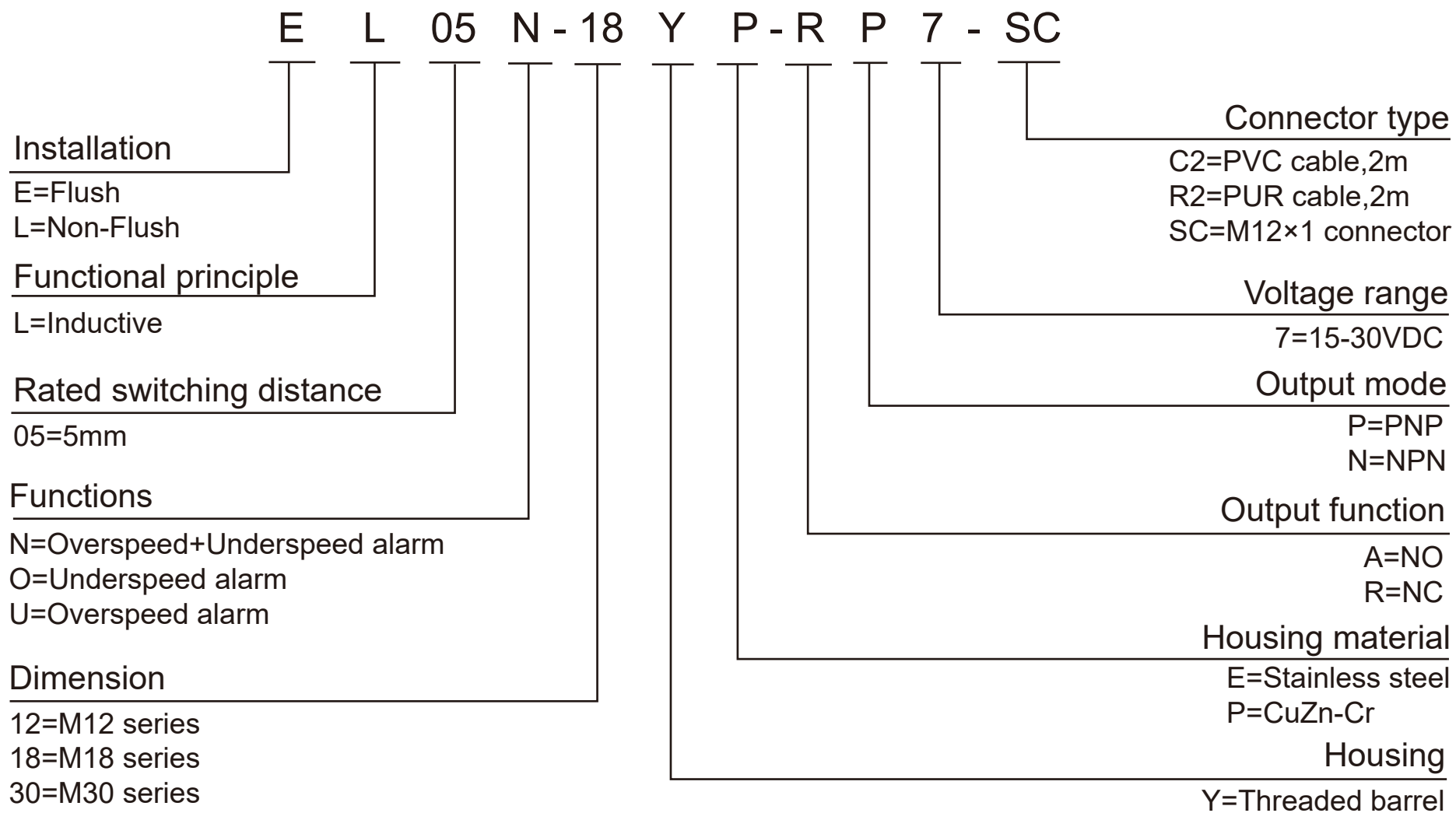

Dimensions

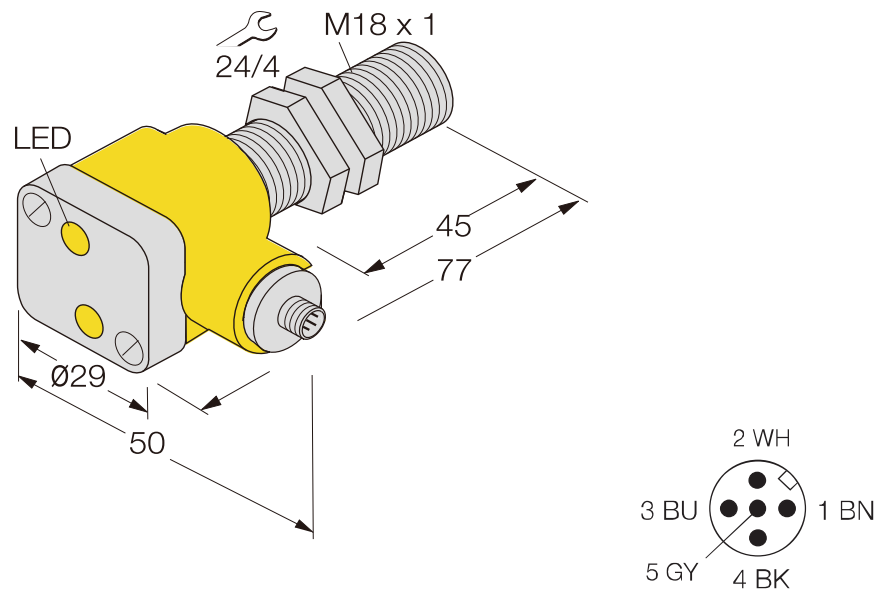

Type

EL05U-18YP-AP7-SC

| | |
|---------------------------|---------------------------|
| Housing material | PBT |
| Probe material | CuZn-Cr |
| Probe size | M18×1 threaded barrel |
| Rated voltage | 18-30VDC |
| Load current | 200mA DC |
| Ambient temperature range | -25...+85°C |
| Monitoring range | 6...6000min ⁻¹ |
| Type of protection | IP67 |
| Number of Pins | 5 |
| Output mode | PNP |
| Setting mode | Remote teaching line |
| Connector type | M12×1 connector |

Application

- Lubrication
- Cooling
- Hydraulics
- Metallurgy industry
- Metal processing
- Auto Industry
- Logistical Packaging
- Machining Industry



TIANJIN SENTINEL ELECTRONICS CO.,LTD.

Tel : 86-22-85689572 83726973

Fax : 86-22-85689517

E-mail : info@sentinel-china.com

For more details, please visit

www.sentinel-china.com 

SENSING YOUR MIND!